



EMERSON[™]
Industrial Automation



Quantum MP

DC Drive Package

45 A to 700 A

208 V-480 V



The complete DC drive package.

Developed by the pioneer in DC drive technology, the new Control Techniques Quantum MP is the most advanced DC drive package available, providing optimum performance and a high degree of versatile system interfacing capability. This 5th generation DC drive replaces the Quantum III and integrates the control platform from the world's leading intelligent AC drive, Unidrive SP.

Existing Quantum III customers can easily migrate to the new MP platform. Control terminals are the same format as the Quantum III and free software tools are available to assist in transferring drive parameters and programs. Quantum MP is also an ideal retrofit choice when upgrading other manufacturers' obsolete drives.

Upgrading your control system

DC drives provide many performance advantages, especially in regenerative and high power applications. Most DC motors in use today are easily capable of providing continued service. Upgrading your drive to the Quantum MP allows you to maximize motor performance, enhance system reliability and interface digitally with the latest control equipment using Ethernet and a wide range of industrial networks. If you are planning to upgrade your Quantum or other manufacturer's DC system, Quantum MP is the clear choice.

Quantum MP DC drive features

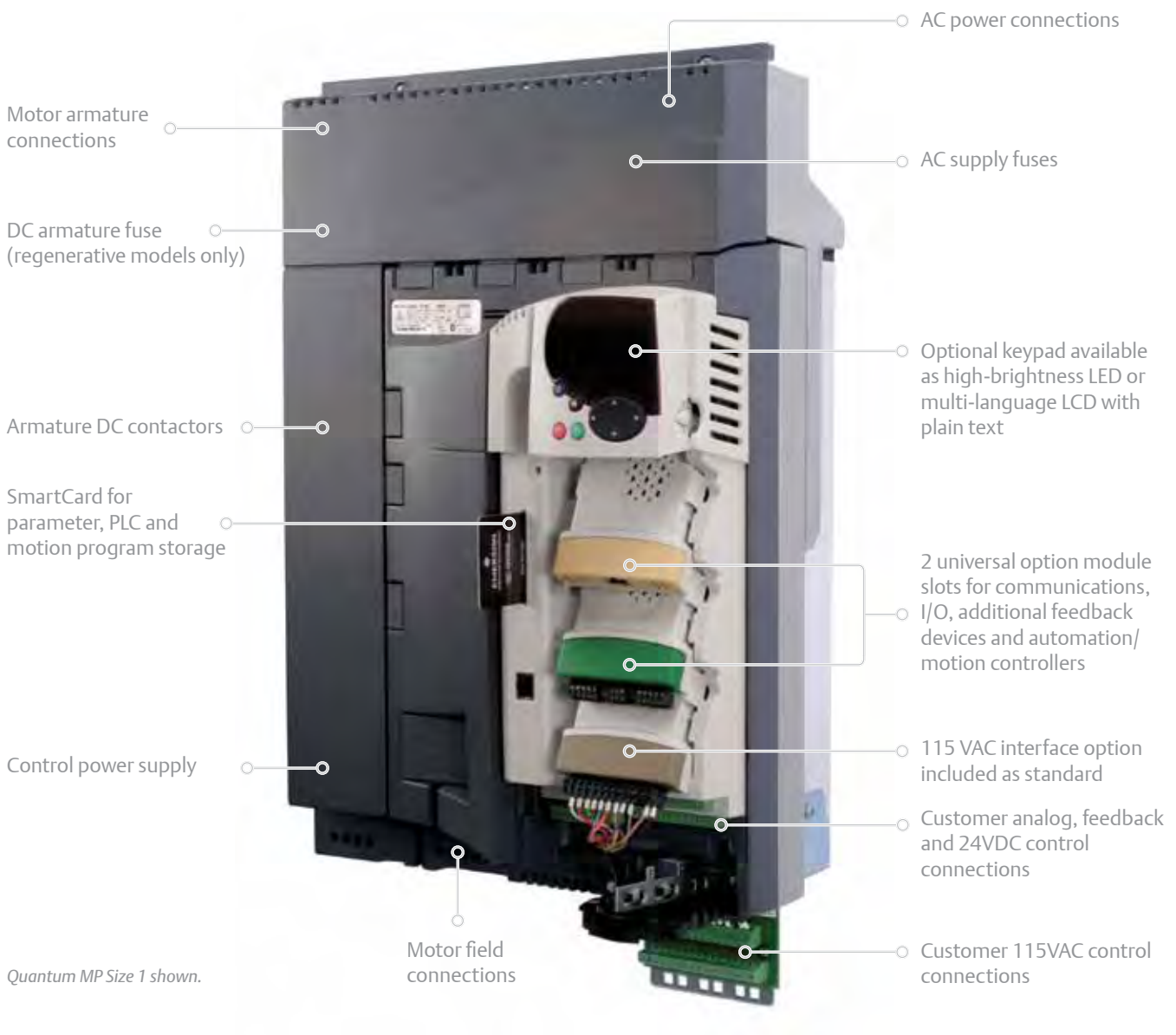

Ratings and dimensions

Model		Frame	Armature Current (A)	Field Current (A)	Height (H)	Width (W)	Depth (D)
Non-Regenerative	Regenerative						
QMP45A4-xxx	QMP45A4R-xxx	1A	45	8	22.8 in (578 mm)	13.0 in (330 mm)	8.7 in (221 mm)
QMP75A4-xxx	QMP75A4R-xxx		75				
QMP155A4-xxx	QMP155A4R-xxx	1B	155	8	22.8 in (578 mm)	13.0 in (330 mm)	9.8 in (250 mm)
QMP210A4-xxx	QMP210A4R-xxx		210				
QMP350A4-xxx	QMP350A4R-xxx	2A	350	20	35.0 in (889 mm)	20.3 in (516 mm)	13.0 in (330 mm)
QMP400A4-xxx	QMP400A4R-xxx		400				
QMP550A4-xxx	QMP550A4R-xxx	2B	550	20	36.0 in (915 mm)	20.3 in (516 mm)	15.0 in (381 mm)
QMP700A4-xxx	QMP700A4R-xxx		700				

Order string

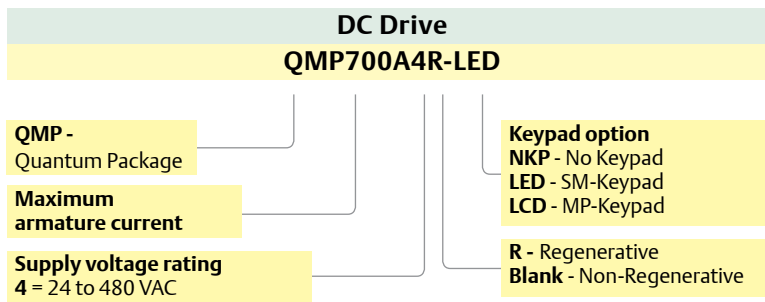

Quantum MP packaging

Quantum MP Size 1 drives provide the same control interface as the Quantum III packaged in an enclosure with a different aspect ratio.

The Size 2 package has the same footprint as the existing equivalent Quantum III. The designs provide easier system

integration for current Quantum III customers. Quantum MP drives can also be easily integrated into other existing DC motor applications.

Box-it!™ packaged drives and pre-engineered systems

Control Techniques can supply Quantum MP-based DC motor control solutions in industry standard enclosures with a wide range of options and accessories including disconnects, fusing, contactors and control equipment.

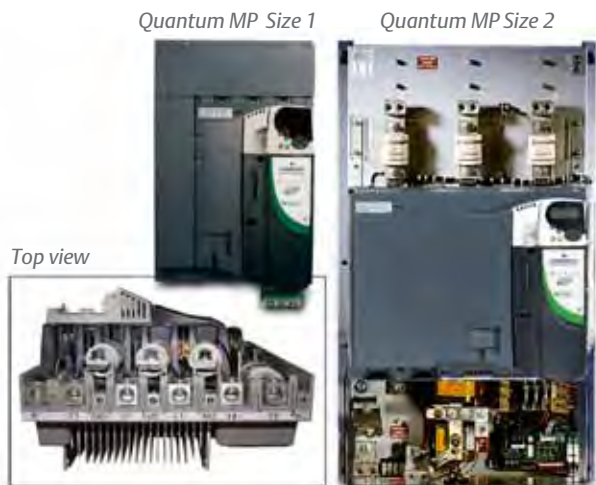

Control Mode

Armature Voltage Feedback



Tach Feedback



Encoder Feedback



Field Control

Options

Standard

Mentor MP in field mode
greater than 25 A



FXMP25
Field Control
up to 25 A



Integrated Field Control
Size 1: 8A
Size 2: 20 A



Drive Programming and Operator Interface

Operator Interface



CTSoft
CTScope

MP-Keypad
LCD Display



SM-Keypad
LED Display



SmartCard



Input/Output

Standard

Options



SM-I/O 32



SM-I/O Plus



SM-I/O Lite



SM-I/O Timer



SM-I/O 120V



SM-PELV



REMOTE I/O

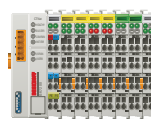

- 7 Digital I/O (115VAC)
- 7 Digital I/O (24VDC)
- 5 Analog I/O
- 2 Form C relays

Centralized PLC



PLC



NTUM



Integration versatility

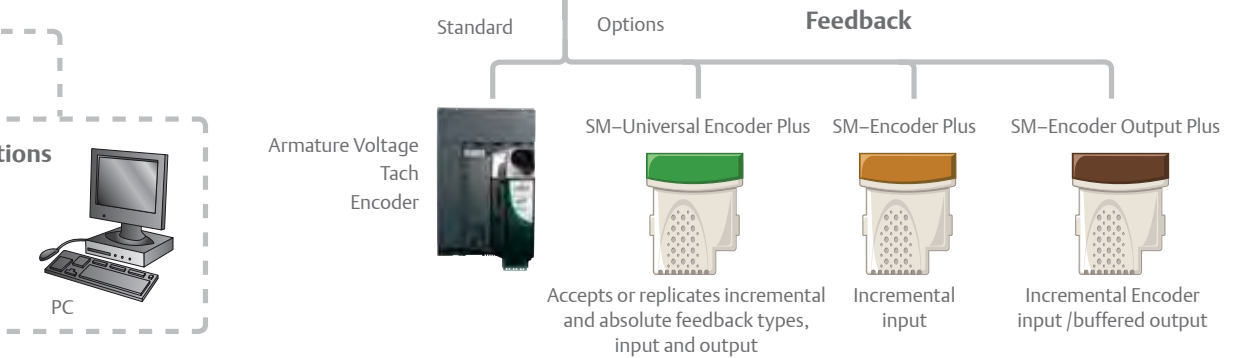
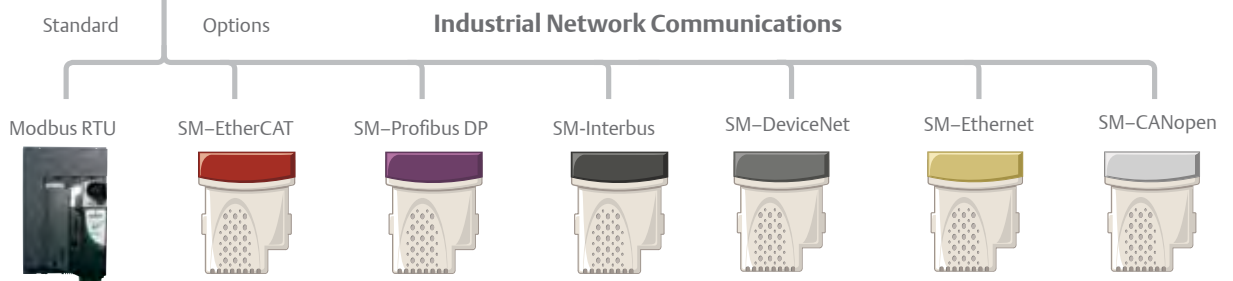
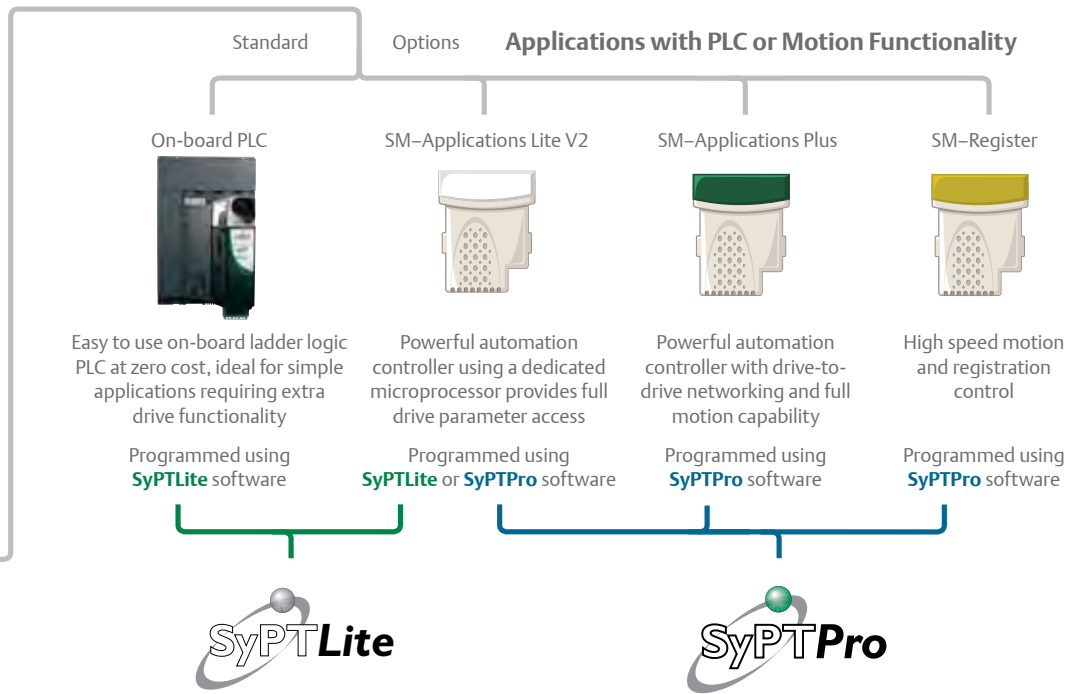

PC/Motion Control Options



Motion Controller



PC

Options

Configuration Tools	Description	Order Code	Notes
Base Drive Configuration	Cloning and Parameter Storage	SmartCard	Shipped FREE with every order
	Configuration Software	CTSoft	Shipped FREE with every order
	Digital Oscilloscope	CTScope	Shipped FREE with every order
	Communications Cable - RS232/485	CT-Comms-Cable	RS232 PC-to-drive cable
	Communications Cable - USB	CT-USB-Cable	USB PC-to-drive cable
Operator Interface	LED Keypad	SM-Keypad	Bright, high-visibility LED display
	LCD Keypad	MP-Keypad	Multi-language display with help
	Programmable HMI Panels	CTVue series	Graphic and touchscreen operator interfaces
Solutions Modules	Description	Order Code	Notes
I/O	120/240 VAC I/O	SM-I/O-120 V	6 x 120 VAC inputs (or 3 x 240 VAC)
	24 V Protected I/O (48 V withstand)	SM-I/O-24 V	3 x digital inputs, 4 x digital I/O, 2 x relays, 2 x analog mA inputs
	32 Point Digital I/O	SM-I/O-32	SyPT Lite or SyPTPro software required for full 32 I/O configuration
	Extra I/O with Encoder Reference	SM-I/O-Lite	3 x digital inputs, encoder input, 1 x relay, 1 x analog input, 1 x analog output
	Protective Extra Low Voltage I/O	SM-I/O-PELV	1 x digital input, 4 x digital I/O, 2 x relays, 2 x analog mA inputs, 1 x analog output
	Extended Analog and Digital I/O	SM-I/O-Plus	3 x digital inputs, 3 x digital I/O, 2 x relays, 2 x analog V inputs, 1 x analog V output
	Extra I/O with Real-Time Clock/Calendar	SM-I/O-Timer	3 x digital inputs, encoder input, 1 x relay, 1 x analog input, 1 x analog output
	Remote CTNet Network I/O	Refer to factory	Connects to drive via CTNet port on SM-Apps-Plus
Feedback	Universal Encoder Feedback	SM-Uni-Encoder	Absolute and incremental encoders, SinCos, SSI, Hyperface and Endat signals supported
	Incremental Encoder Input	SM-Encoder-Plus	Incremental encoder feedback
	Incremental Encoder Input & Output	SM-Encoder-Out	Incremental encoder feedback plus simulated encoder output
Programmable Control	Systems Programming (Centralized Control)	SM-Apps-Lite-V2	
	Systems Programming (Distributed Control)	SM-Apps-Plus	Includes CTNet, RS485 (Modbus and CTSync) and 4 high speed digital I/O
	High Speed Capture & Registration	SM-Register	Includes CTNet, RS485 (Modbus and CTSync) and 4 high speed digital I/O with enhanced capture functions
PC Programming Tools	Description	Order Code	Notes
Programmable Control	Ladder and Function Blocks	SyPTLite	For use with base drive PLC and SM-Apps-Lite-V2; available as a free download.
System Programming	IEC 61131-3 (Ladder, FB, and Text Based)	SyPTPro	Drive and systems programming software for use with SM-Apps-Lite-V2, SM-Apps-Plus and SM-Register

Accessories

Power

- Dynamic Braking Resistors
- Line Reactors
- EMC Filters
- Field Supply Buck/Boost Transformers
- DC Motors



Specifications

Environment

Ambient Operating	32° to 131°F (0° to 55°C) Derate current 1.5% per °F/C from 104° to 131°F (40° to 55°C)
Cooling Method	QMP25-QMP45 natural convection QMP75 and larger forced convection
Humidity	90% relative humidity at 122°F (50°C)
Storage Temperature	-40° to 131°F (-40° to 55°C)
Altitude	0 to 9,842 ft (0 to 3,000 m), derate 1% per 380 ft (100 m) between 3,280 ft (1,000 m) and 9,842 ft (3,000 m)
Enclosure	IP00

AC Supply Requirements

SCR Supply Voltage	24 to 480 VAC ±10%
Frequency	48 to 65 Hz
Supply Fault Current	100 kA
Auxiliary Supply Voltage	208 to 480 VAC ±10%, 1Ø
Drive Efficiency	99%
Armature Voltage (max.)	Non-regen drives — 1.35 X input VAC; Regen drives — 1.15 X input VAC
Field Voltage (max.)	0.9 X input VAC with 1-phase input

Control

Analog Input Resolution	16-bit plus sign, 250µs (Qty 1), 10-bit plus sign, 250µs (Qty 2)
Speed Loop	250µs loop update
Current Loop	35µs current sampling time
Feedback Methods	Encoder (resolution 0.01%) DC tachometer (resolution 0.1%); AC tachometer (resolution 1%) (300V max.) Armature Voltage (resolution 5%) Optional additional incremental and absolute encoders (Qty 3)
Field Control	Current regulated with flux control QMP25-QMP210 8 A QMP350-QMP1850 20 A Optional FXMP25 25 A
Serial Communications	2- or 4-wire RS422 or RS485, optically-isolated Protocol is ANSI x 3.28-2.54-A4 or Modbus RTU Baud rate is 300 to 115,200

Protection & Diagnostics

Control	Galvanic electrical isolation, 24 VDC power supply
Supply	Loss, undervoltage, overvoltage, transient suppression, semiconductor fuses
Armature	Open circuit, I ² t overload, instantaneous overcurrent, semiconductor fuse (regen only)
Field	Loss, overcurrent
Motor	Motor over-temp switch or thermistor overtemperature trips
Drive Thermal	Heatsink, SCR junction, control board and option module(s)
Current Loop Loss	Loss of analog current reference

120 VAC I/O

Inputs	- EMERGENCY STOP - STOP - RUN - JOG - FWD/REV - RESET
Outputs	DRIVE ON
Relays	2

24 VDC I/O

Digital Inputs	3 x 24 VDC
Digital Input/Outputs	3 x 24 VDC
Analog Inputs	1 x 16 bit differential 0-10 V, 2 x 10 bit voltage or mA
Analog Outputs	2 x 10 bit voltage or mA



RoHS
Compliant

